

DATE	BY	DESCRIPTION	REVISION	DATE	BY	APPROVED
NC	NC	INITIAL RELEASE				

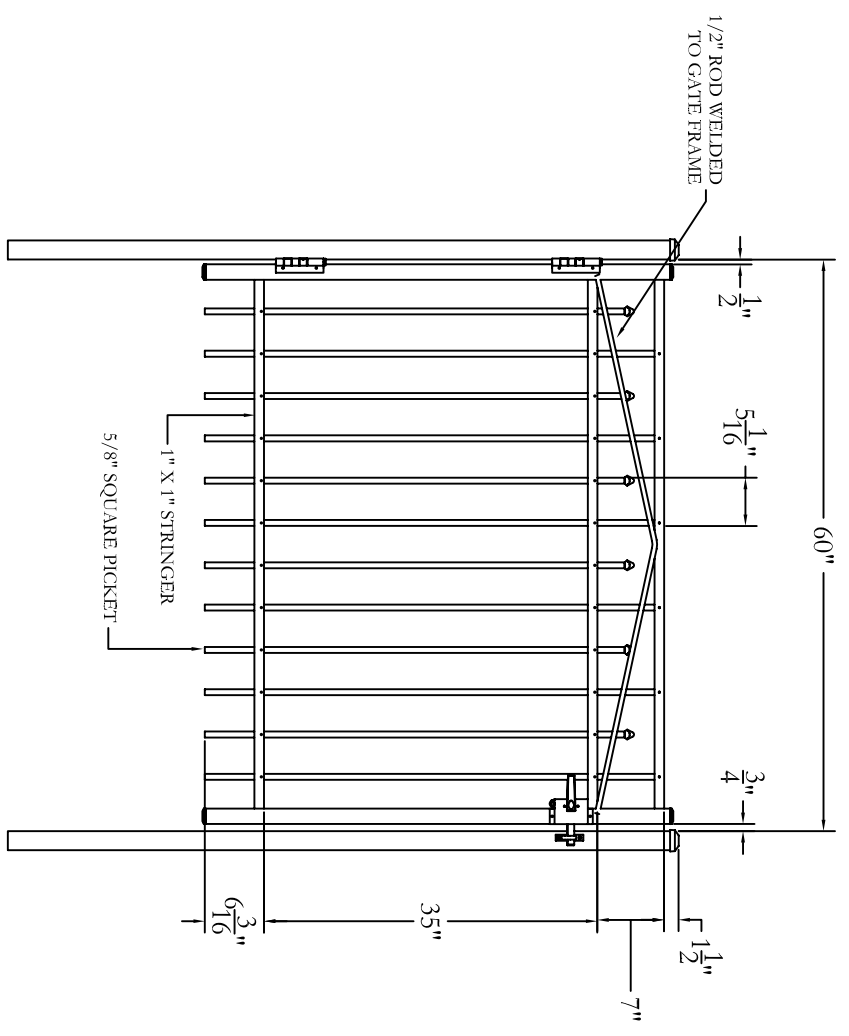
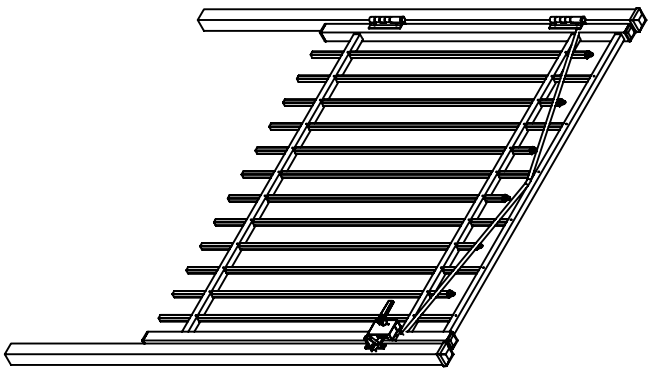

Jerth
 Manufacturing Co., Inc.
 Philadelphia, PA 19154
 (800) 344-2242

DRAWING:
 RESIDENTIAL GATE
 STYLE #200
 48" HIGH X 60" WIDE

SIZE	DWG NO.	REV
D	RS48U20060	NC
SCALE	DATE	SHEET
	1-1-05	1 OF 1

© 2005. This drawing may not be altered or reproduced without the permission of Jerth Manufacturing Co., Inc.