

ZONE	REV	DESCRIPTION	DATE	APPROVED
-	NC	INITIAL RELEASE		

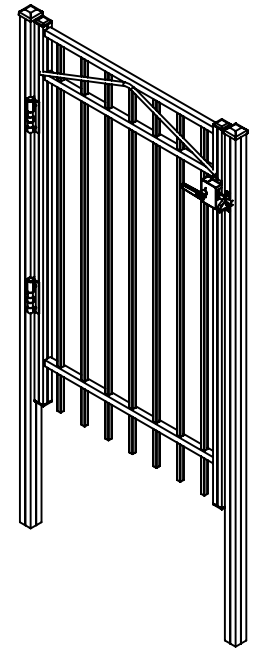
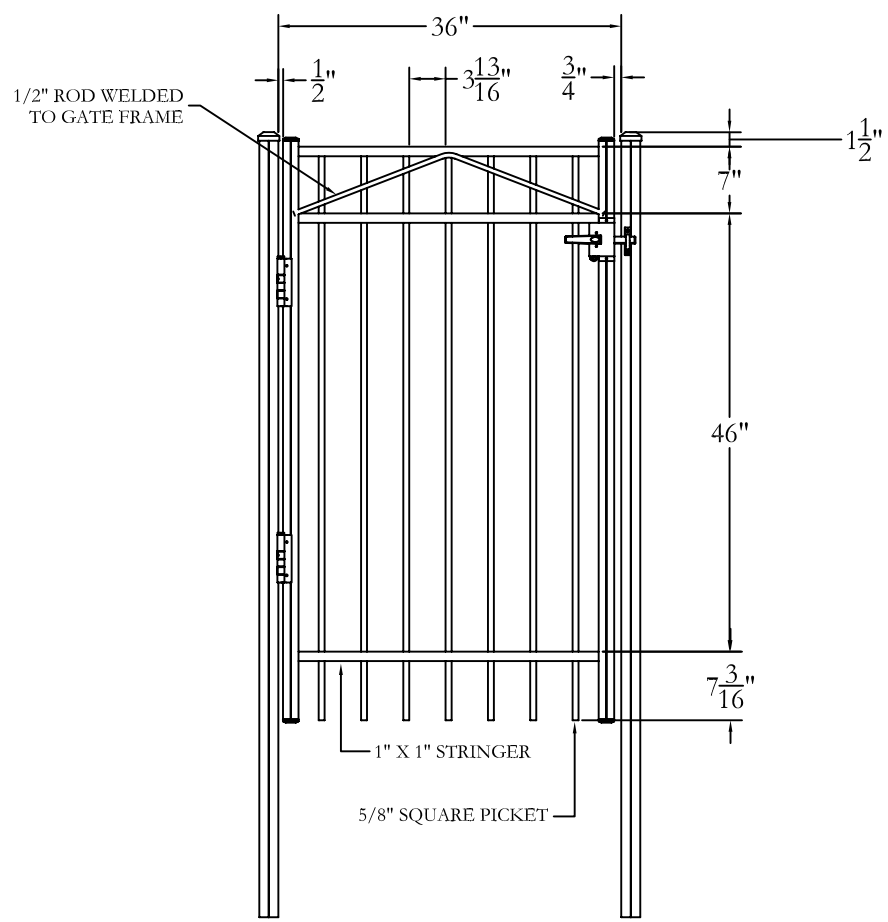

Jerith[®]
 Manufacturing Co., Inc.
 Philadelphia, PA 19154
 (800)344-2242

DRAWING:
 LIBERTY GATE
 STYLE #202
 60" HIGH X 36" WIDE

SIZE D	DWG NO. LI60U2236	REV NC
SCALE	DATE 1-11-2010	SHEET 1 OF 1

© 2005. This drawing may not be altered or reproduced without the permission of Jerith Manufacturing Co., Inc.