

ZONE		REV	DESCRIPTION	DATE	APPROVED
-	NC		INITIAL RELEASE		

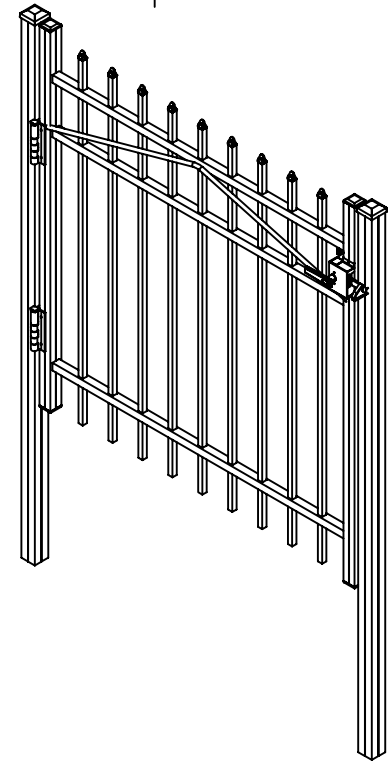
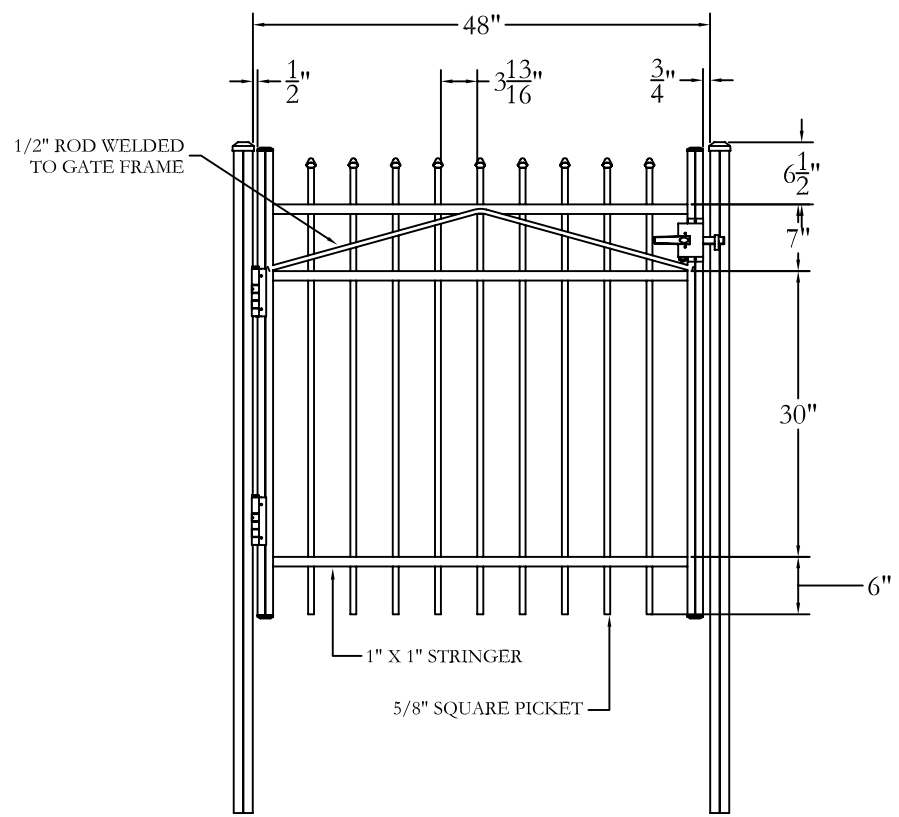

Jerith[®]
 Manufacturing Co., Inc.
 Philadelphia, PA 19154
 (800)344-2242

DRAWING:
 LIBERTY GATE
 STYLE #101
 48" HIGH X 48" WIDE

SIZE D	DWG NO. LI48U1148	REV NC
SCALE	DATE 1-11-2010	SHEET 1 OF 1

© 2005. This drawing may not be altered or reproduced without the permission of Jerith Manufacturing Co., Inc.