

ZONE		REV	DESCRIPTION	DATE	APPROVED
-	NC		INITIAL RELEASE		

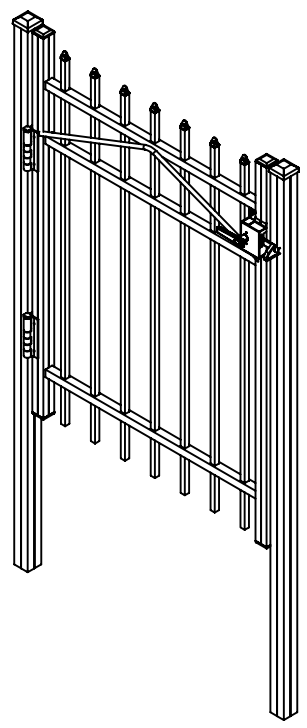
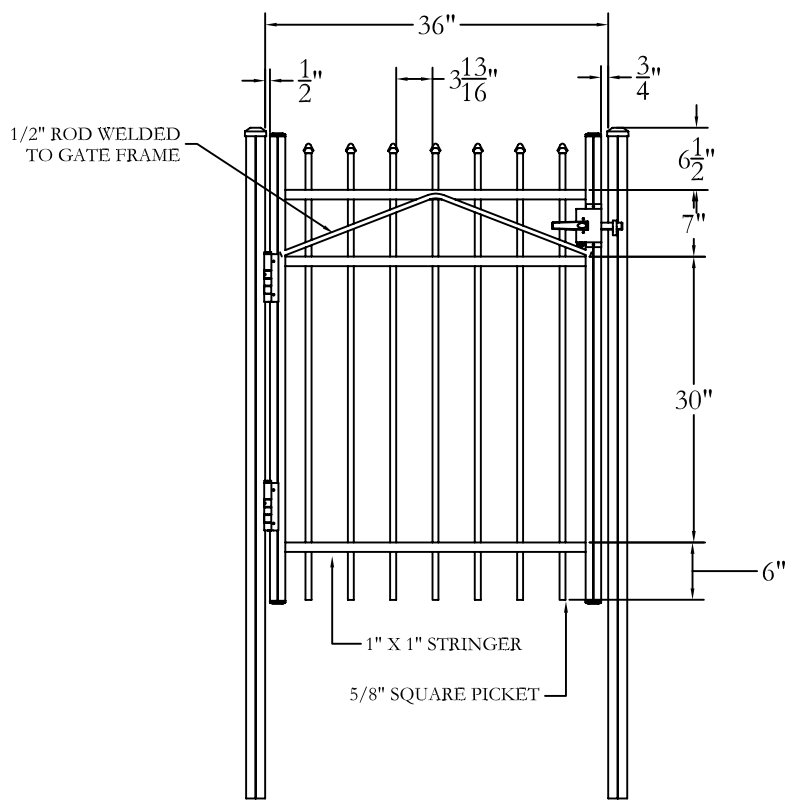

*Jerith*<sup>®</sup>  
 Manufacturing Co., Inc.  
 Philadelphia, PA 19154  
 (800)344-2242

DRAWING: LIBERTY GATE  
 STYLE #101  
 48" HIGH X 36" WIDE

SIZE D	DWG NO. LI48U1136	REV NC
SCALE	DATE 1-11-2010	SHEET 1 OF 1

© 2005. This drawing may not be altered or reproduced without the permission of Jerith Manufacturing Co., Inc.