

ZONE		REV	DESCRIPTION	DATE	APPROVED
-	NC		INITIAL RELEASE		

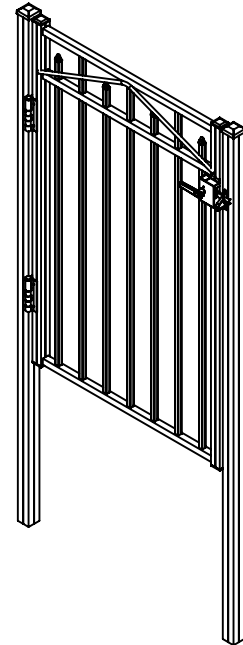
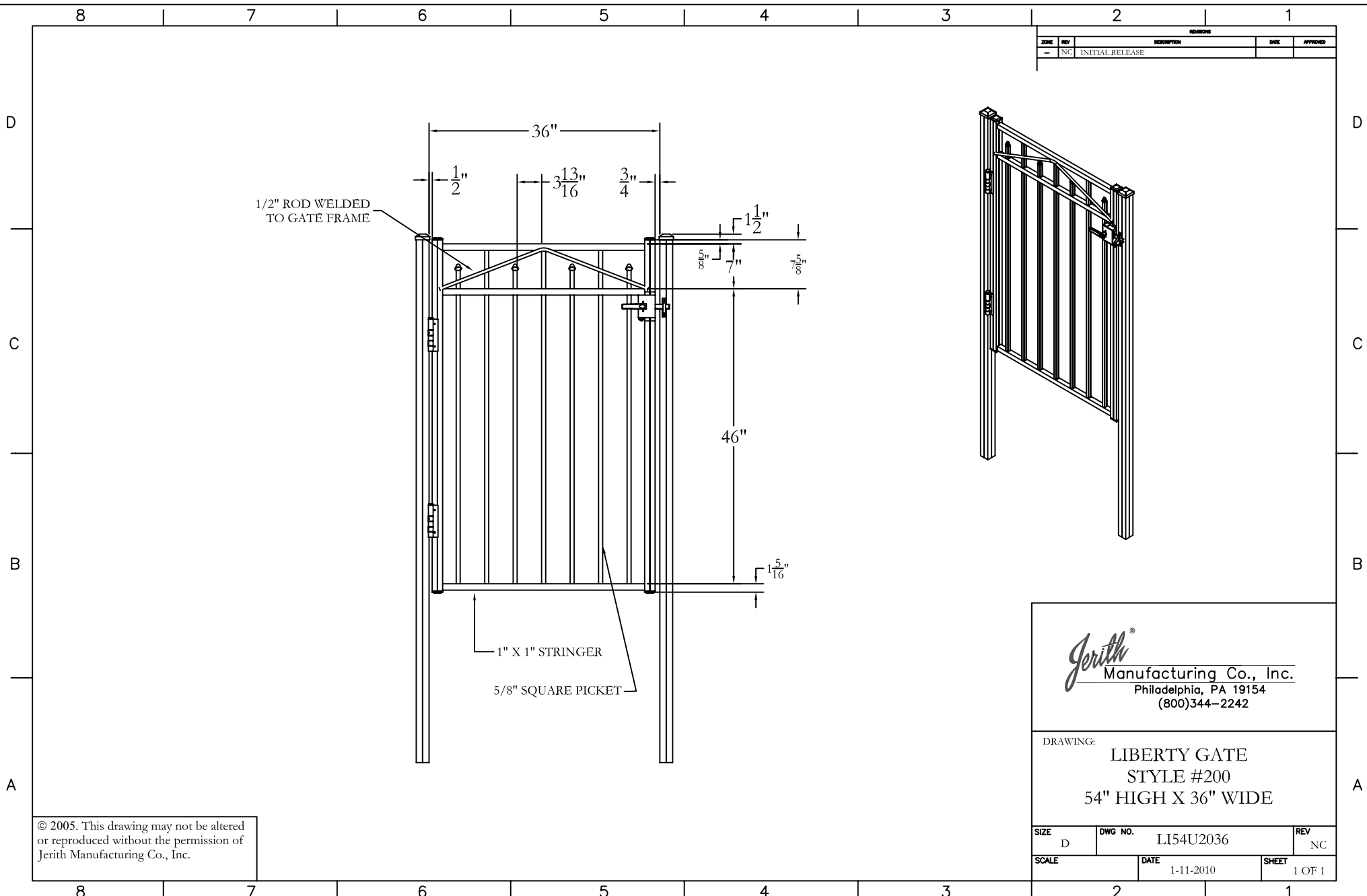

Jerith[®]
 Manufacturing Co., Inc.
 Philadelphia, PA 19154
 (800)344-2242

DRAWING: LIBERTY GATE
 STYLE #200
 54" HIGH X 36" WIDE

SIZE D	DWG NO. LI54U2036	REV NC
SCALE	DATE 1-11-2010	SHEET 1 OF 1

© 2005. This drawing may not be altered or reproduced without the permission of Jerith Manufacturing Co., Inc.

ZONE		REV	DESCRIPTION	DATE	APPROVED
-	NC		INITIAL RELEASE		

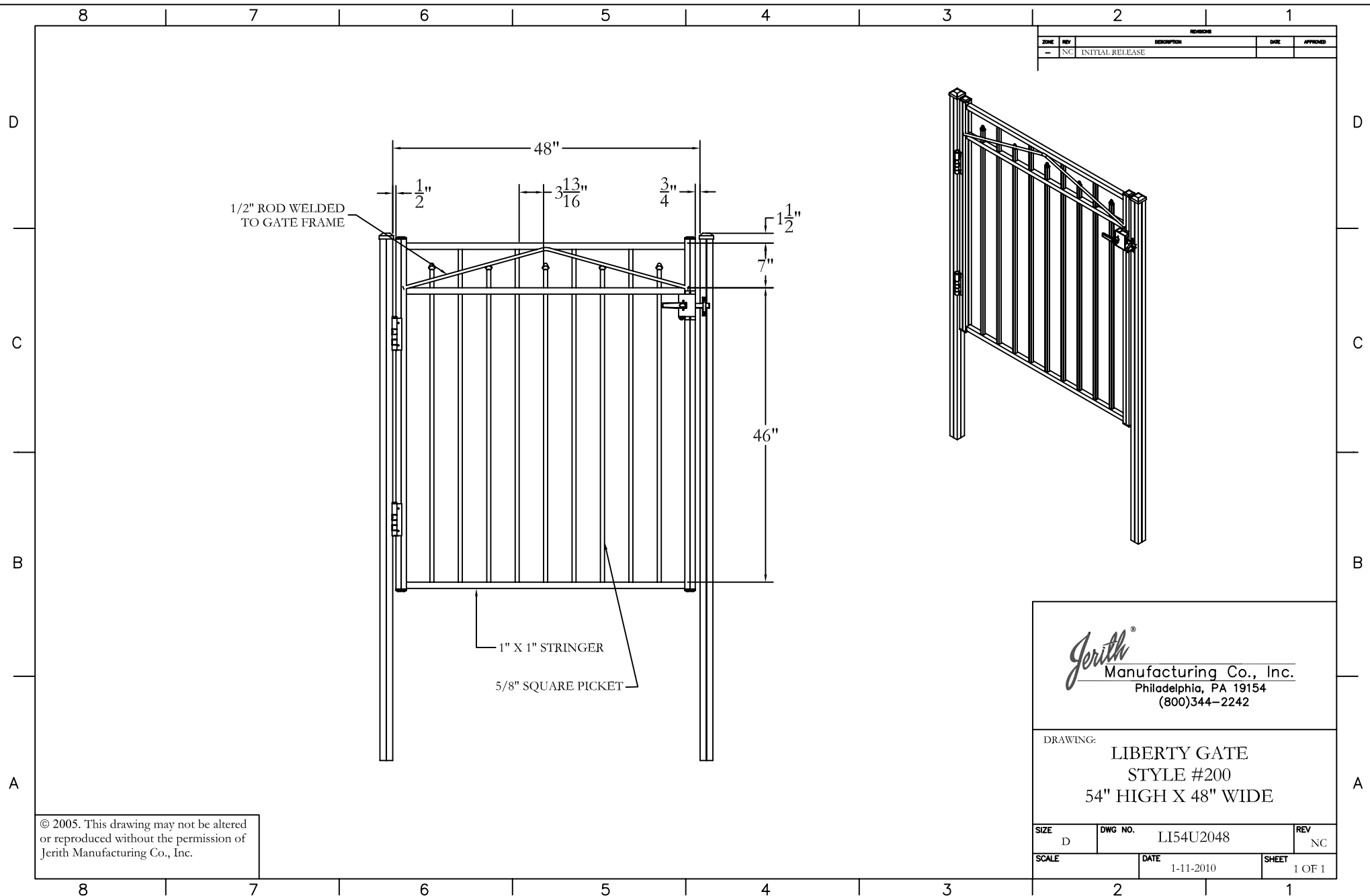

1/2" ROD WELDED TO GATE FRAME

1" X 1" STRINGER

5/8" SQUARE PICKET

Jerith[®]
 Manufacturing Co., Inc.
 Philadelphia, PA 19154
 (800)344-2242

DRAWING: LIBERTY GATE
 STYLE #200
 54" HIGH X 48" WIDE

© 2005. This drawing may not be altered or reproduced without the permission of Jerith Manufacturing Co., Inc.

SIZE D	DWG NO. L154U2048	REV NC
SCALE	DATE 1-11-2010	SHEET 1 OF 1

ZONE		REV	DESCRIPTION	DATE	APPROVED
-	NC		INITIAL RELEASE		

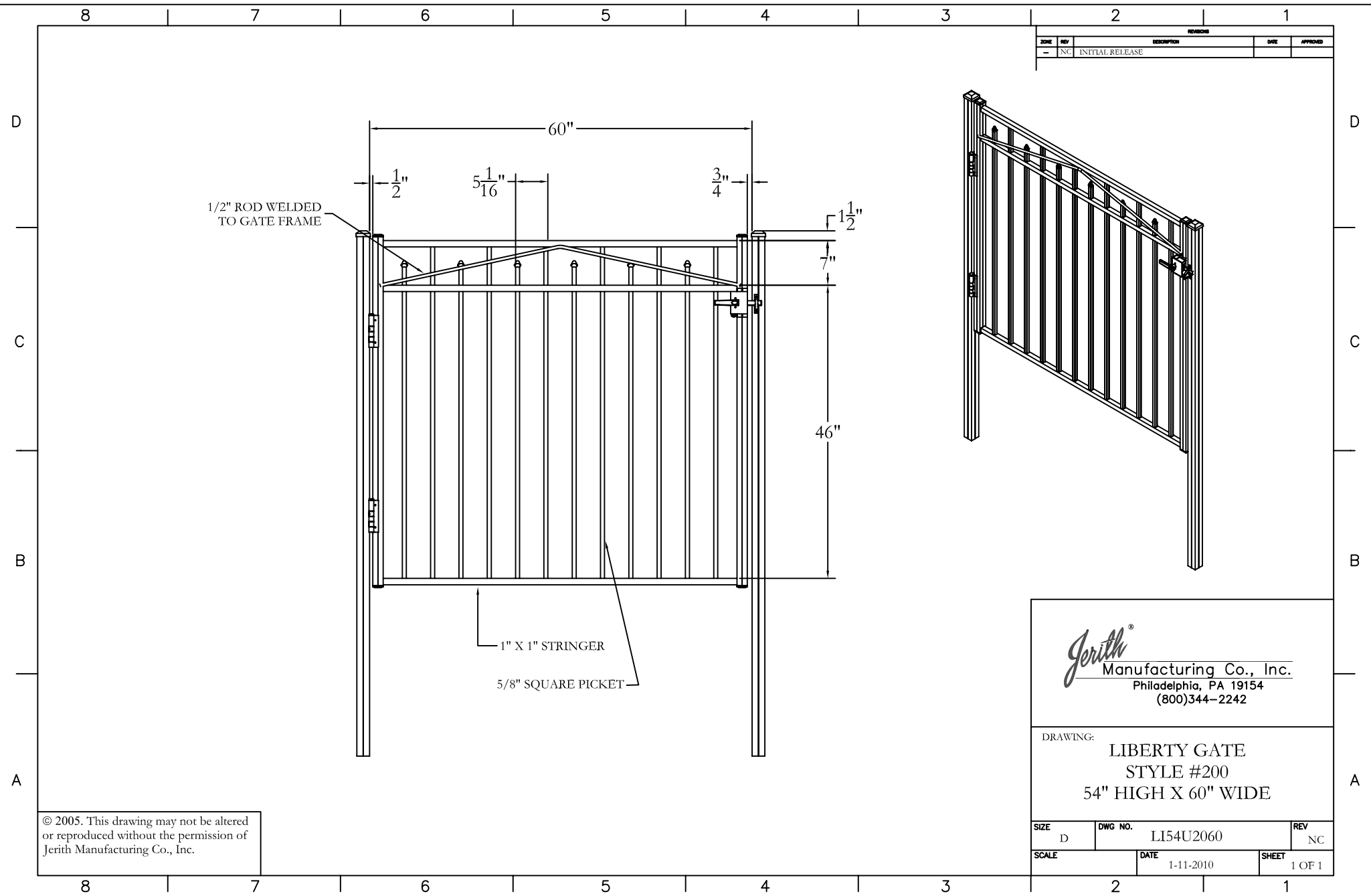

1/2" ROD WELDED TO GATE FRAME

1" X 1" STRINGER

5/8" SQUARE PICKET

Jerith[®]
 Manufacturing Co., Inc.
 Philadelphia, PA 19154
 (800)344-2242

DRAWING:
 LIBERTY GATE
 STYLE #200
 54" HIGH X 60" WIDE

© 2005. This drawing may not be altered or reproduced without the permission of Jerith Manufacturing Co., Inc.

SIZE D	DWG NO. LI54U2060	REV NC
SCALE	DATE 1-11-2010	SHEET 1 OF 1

ZONE		REV	DESCRIPTION	DATE	APPROVED
-	NC		INITIAL RELEASE		

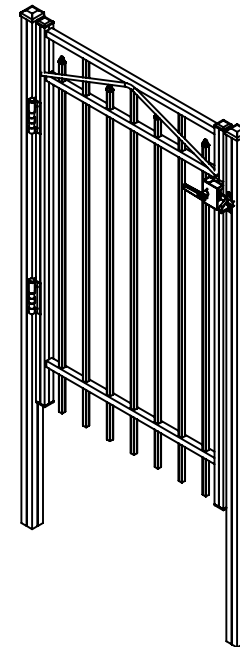
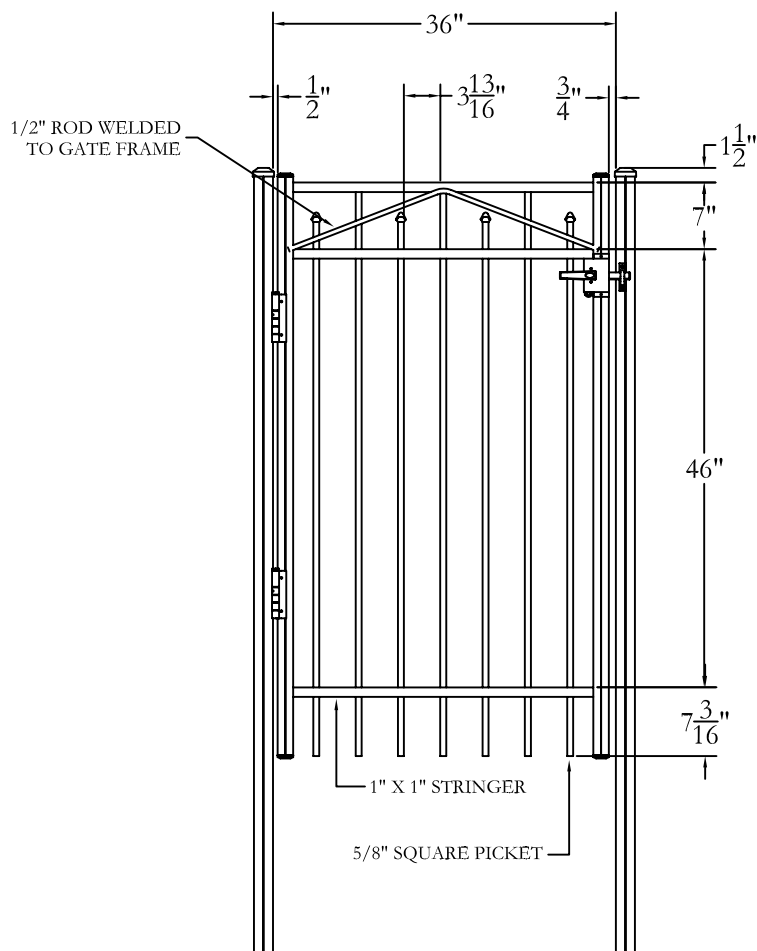

Jerith[®]
 Manufacturing Co., Inc.
 Philadelphia, PA 19154
 (800)344-2242

DRAWING:
 LIBERTY GATE
 STYLE #200
 60" HIGH X 36" WIDE

SIZE D	DWG NO. LI60U2036	REV NC
SCALE	DATE 1-12-2010	SHEET 1 OF 1

© 2005. This drawing may not be altered or reproduced without the permission of Jerith Manufacturing Co., Inc.

ZONE		REV	DESCRIPTION	DATE	APPROVED
-	NC		INITIAL RELEASE		

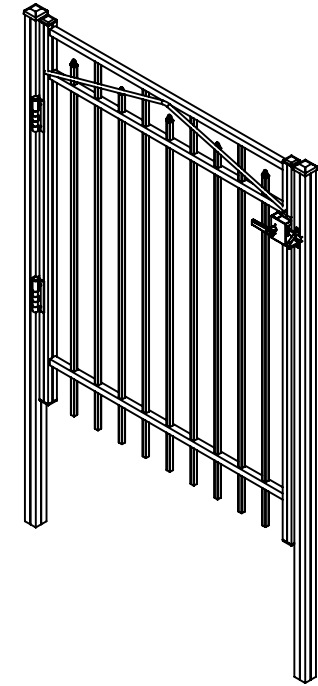
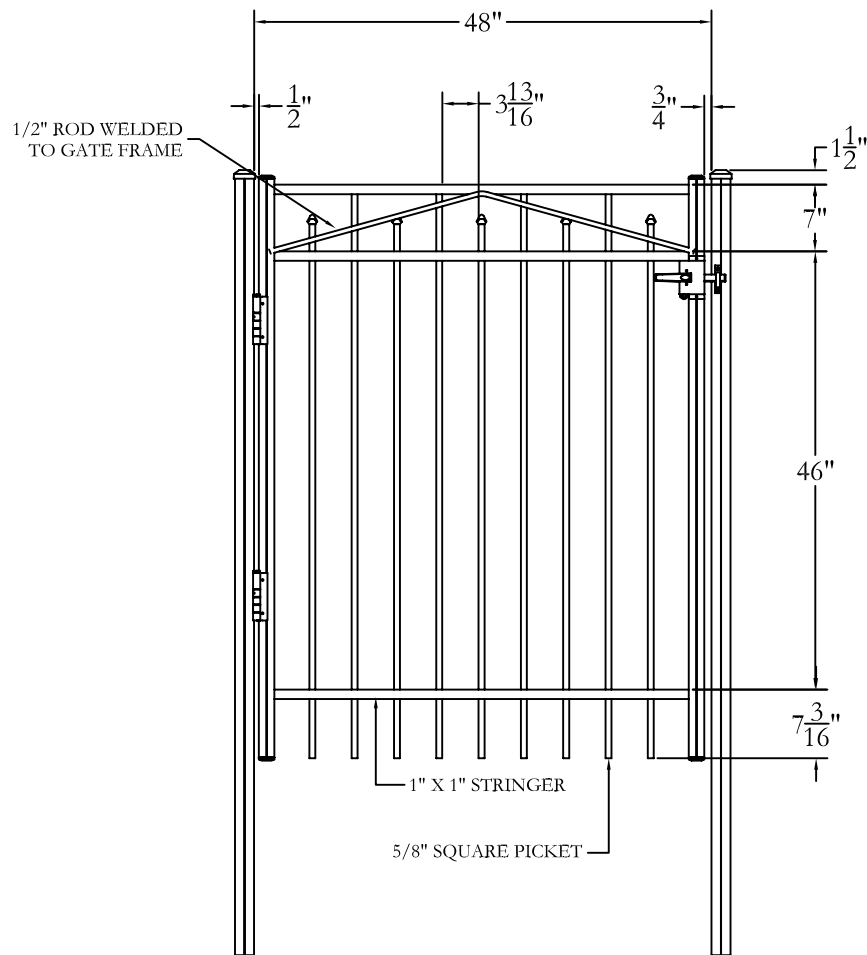

Jerith[®]
 Manufacturing Co., Inc.
 Philadelphia, PA 19154
 (800)344-2242

DRAWING: LIBERTY GATE
 STYLE #200
 60" HIGH X 48" WIDE

SIZE D	DWG NO. LI60U2048	REV NC
SCALE	DATE 1-12-2010	SHEET 1 OF 1

© 2005. This drawing may not be altered or reproduced without the permission of Jerith Manufacturing Co., Inc.

ZONE	REV	DESCRIPTION	DATE	APPROVED
-	NC	INITIAL RELEASE		

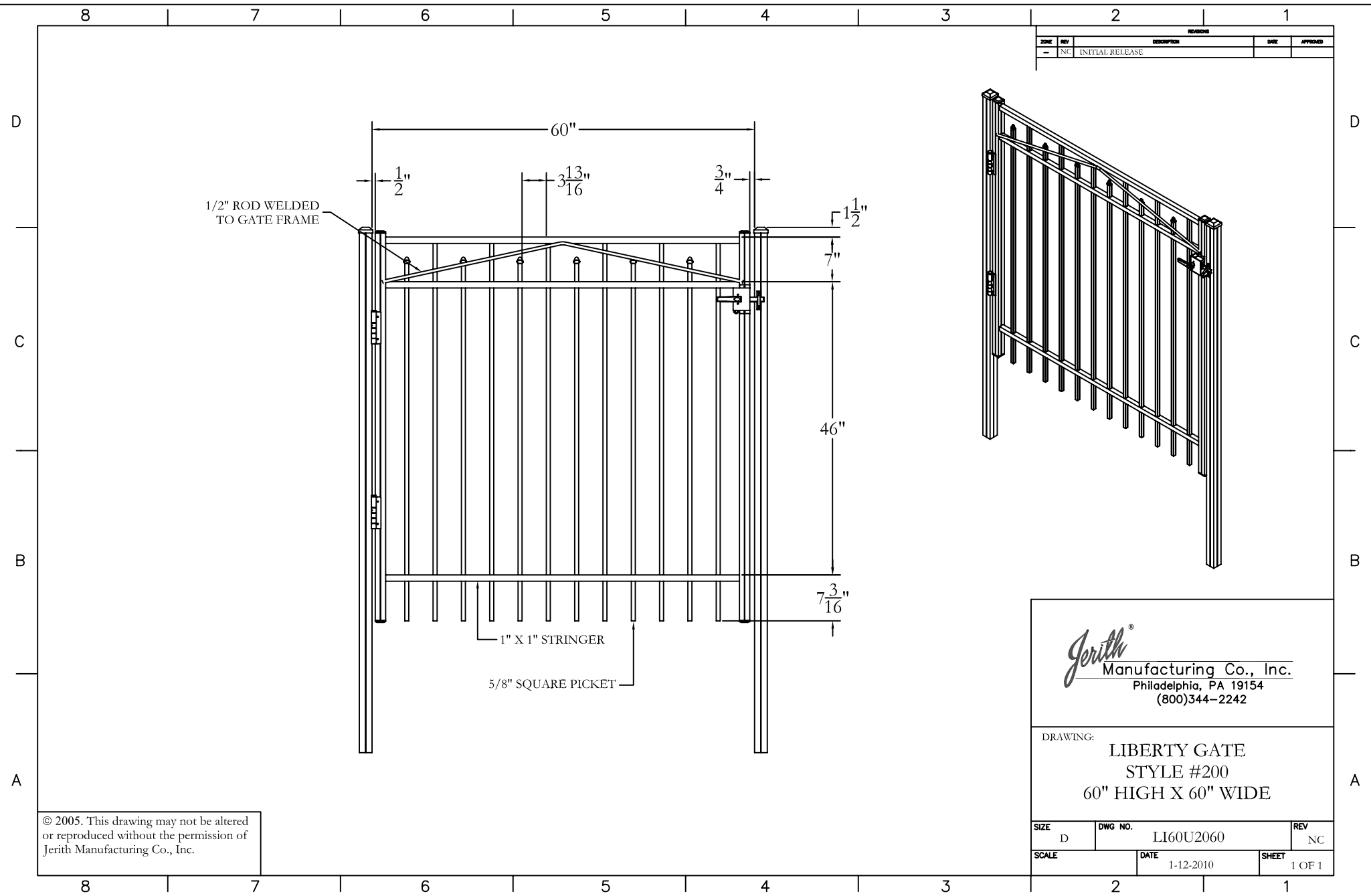

1/2" ROD WELDED TO GATE FRAME

1" X 1" STRINGER

5/8" SQUARE PICKET

Jerith[®]
 Manufacturing Co., Inc.
 Philadelphia, PA 19154
 (800)344-2242

DRAWING:
 LIBERTY GATE
 STYLE #200
 60" HIGH X 60" WIDE

© 2005. This drawing may not be altered or reproduced without the permission of Jerith Manufacturing Co., Inc.

SIZE D	DWG NO. LI60U2060	REV NC
SCALE	DATE 1-12-2010	SHEET 1 OF 1