

1" X 1-1/2" STRINGER

5" SQUARE PICKET

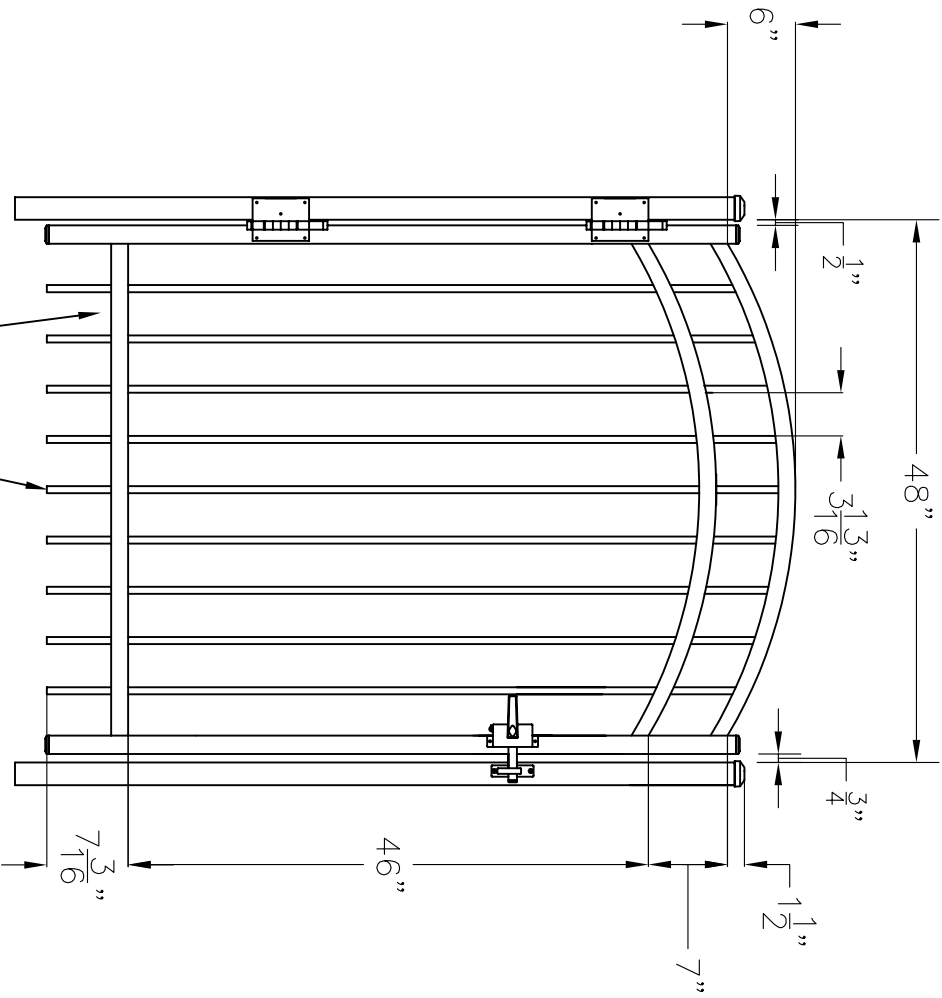

*Jenith*  
Manufacturing Co., Inc.  
Philadelphia, PA 19154  
(800)344-2242

RESIDENTIAL ACCENT GATE  
STYLE #202  
60" HIGH X 48" WIDE

Copyright 2004  
The drawing  
may be reproduced  
without permission of  
Jenith Manufacturing Co., Inc.  
Date September 2004  
Drawing No. RS60U20248