

Parts List		
ITEM	QTY	DESCRIPTION
1	2	82" POST
2	15	54" PICKET
3	1	15 HOLE HEADER
4	2	15 HOLE STRINGER
5	2	POST CAP

REVISIONS				
ZONE	REV	DESCRIPTION	DATE	APPROVED
		INITIAL RELEASE		
	A	ADD 15TH PICKET, CHG STRINGER MATERIAL, CHG STRINGER LENGTH, REMOVE SCREWS, UPDATE PARTS LIST	7-29-2010	SR

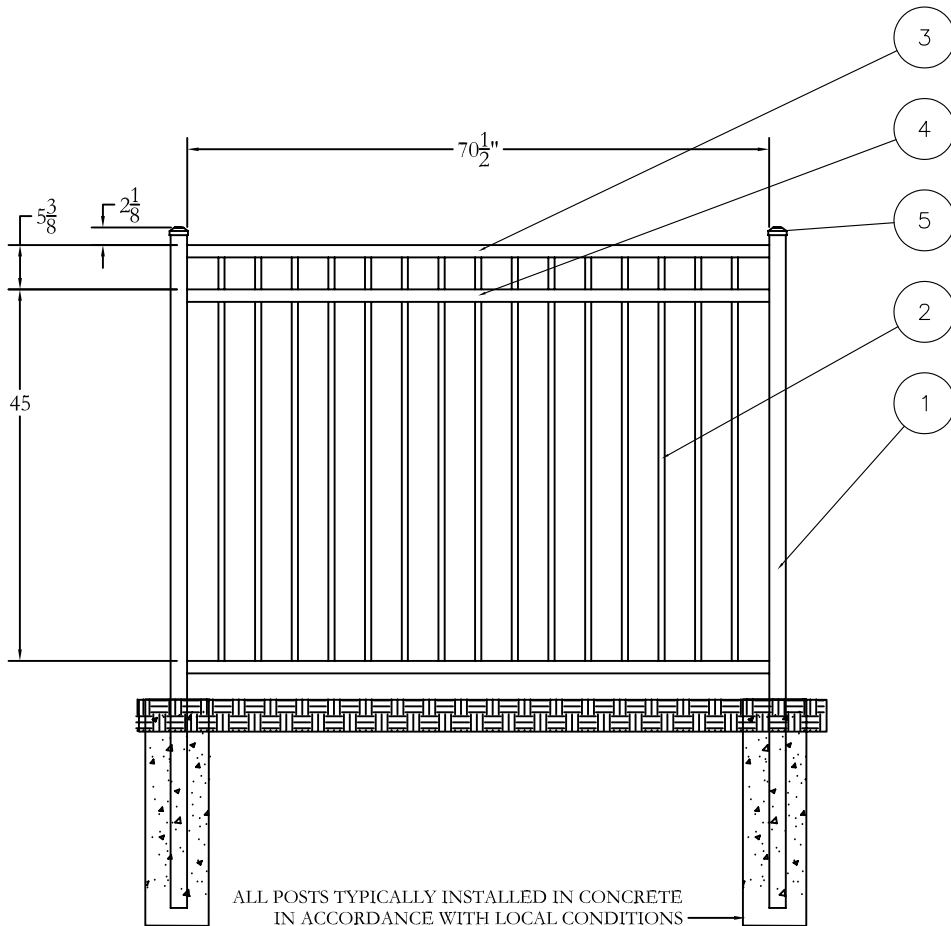

ALL POSTS TYPICALLY INSTALLED IN CONCRETE IN ACCORDANCE WITH LOCAL CONDITIONS AND STANDARD BUILDING PRACTICES

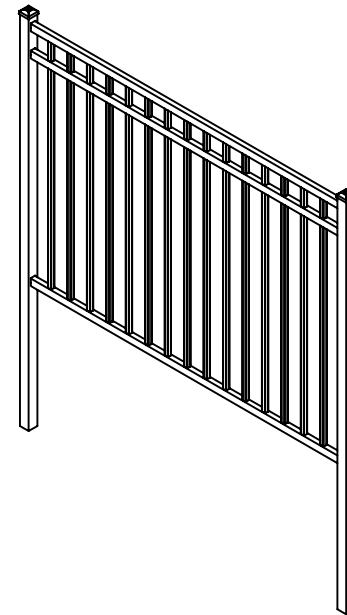

Jerith[®]
 Manufacturing Co., Inc.
 Philadelphia, PA 19154
 (800)344-2242

DRAWING:
WINDSOR FENCE
54" HEIGHT

SIZE D	DWG NO. RG54UWSN	REV NC
SCALE	DATE 7-26-2010	SHEET 1 OF 1

© 2005. This drawing may not be altered or reproduced without the permission of Jerith Manufacturing Co., Inc.